

# LUMEL

DIN RAIL MOUNT  
THREE PHASE ENERGY METER

**NMID32, NMID32LITE, NMID32MBUS,  
NMID31, NMID31LITE, NMID31MBUS**



USER MANUAL



# DIGITAL ENERGY METER

## Installation & Operating Instructions

<b>Section</b>	<b>Contents</b>
1.	Introduction
2.	Measurement and Energy/Counter Screens
	2.1 Startup screens
	2.2 Current Reversal Screen
	2.3 Run Hour
	2.4 On Hour
	2.5 Number of Interruption
3.	Programming
	3.1 Password Protection
	3.2 System Type
	3.3 Potential Transformer Primary Value
	3.4 Potential Transformer Secondary Value
	3.5 Current Transformer Primary Value
	3.6 Current Transformer Secondary Value
	3.7 Demand Integration Time
	3.8 Address Setting
	3.9 Baud Rate
	3.10 Parity
	3.11 Resetting Parameter
	3.12 Pulse Output 1
	3.13 Pulse Output 2
	3.14 Pulse Duration
	3.15 Pulse Rate
	3.16 Display Parameters
	3.17 Backlit
	3.18 Setup Quit

4. Digital Output
  - 4.1 Pulse Output
5. Phasor Diagram
6. Installation
  - 6.1 EMC Installations requirements
  - 6.2 Case Dimensions
  - 6.3 Wiring
  - 6.4 Auxiliary Supply
  - 6.5 Fusing
  - 6.6 Earth/ Ground Connections
  - 6.7 Sealing
7. Errors and Dignostics
8. Connection Diagrams
9. Instruments installation
  - 9.1 Installations with DIN Rail
  - 9.2 RJ 12 Current transformer
10. Connection for optional Pulse Output / Tariff input / RS-485
11. Safety Instructions
12. Specifications

## 1. INTRODUCTION

The Energy Meter is a DIN Rail mounted Quadratic Digital Meter, which measures important electrical parameters in 3 ph 4 wire / 3 wire / 1ph Network and replaces the multiple analog panel meters. It measures electrical parameters like AC voltage, Current, Frequency, Power, Energy (Active / Reactive / Apparent), phase angle, power factor. The PT Primary, PT Secondary, CT Primary, CT Secondary and System Type can be configured & Programmed at the site only in first 15 minutes after entering into setup menu and get locked as per MID standard & if still need to change, user have to press reset key for 3 second & then it allows user for next 15 minutes to edit the same. The front panel has four push buttons using which the user can scroll through different screens & configure the product. The front panel also has Impulse red led, flashing at rate proportional to measured power.

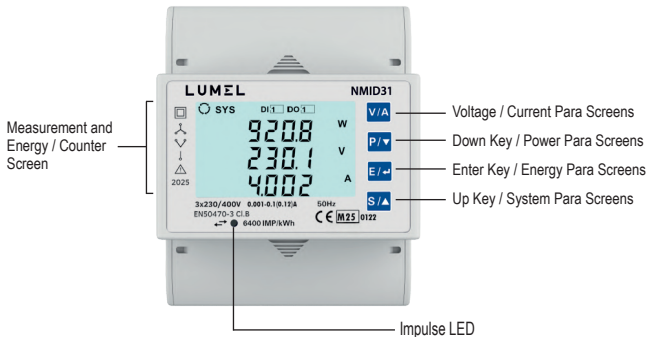

## 2. MEASUREMENT AND ENERGY COUNTER SCREENS

In normal operation, the user is presented with screens given in TABLE 1:

### 1. **System Parameter screens** of TABLE 1.1.

These screens may be scrolled through one at a time in an incremental order by pressing the "System / UP" key to roll over again in same order.

### 2. **Energy / Counter screens** of TABLE 1.2.

These screens may be scrolled through one at a time in an incremental order by pressing the "Energy / ENTER" key to roll over again in same order

### 3. **Power Parameter screens** of TABLE 1.3.

These screens may be scrolled through one at a time in an incremental order by pressing the "Power / DOWN" key to roll over again in same order.

### 4. **Voltage/Current Parameter screens** of TABLE 1.4.

These screens may be scrolled through one at a time in an incremental order by pressing the "V / A" key to roll over again in same order.

### Phase Sequence Indication

It indicates the rotation of input phasor vectors:  
clockwise/ counter-clockwise.

In case the input is absent or the phase sequence is neither L123 nor L321, the phase sequence indication is not shown.



Clockwise Sequence  
for L123.



Counter-Clockwise Sequence,  
for L321.

### Tariff Input Indication

The Tariff Input symbols indicate the following:



"1" Indication on top is for current tariff.

If 1 is ON shows 1 means energy in tariff 1 and if i2 is ON shows 2 means energy in tariff 2.

### Tariff Energies Indication



This Instrument comes with 2 tariff based on Tariff Input 1 (TA) for 6 energies each. In the image given here, it indicates that the instrument is currently displaying the energy parameter (System Import Active Energy) of Tariff 2. Refer TABLE 1.2 for navigation of Tariff Energies. These energies are available in Energy Parameter screens on display.

### MID Setup Open Indication



This screen indicates that the MID setup **OPEN**, user need to set the PT Primary, PT Secondary, CT Primary, CT Secondary and System Type to **LOCK** the setup.

These parameters can be configured & Programmed at the site only in first 15 minutes after entering into setup menu and get locked as per MID standard & if still need to change, user need to break the seal & press reset key for 3 second & then it allows user for next 15 minutes to edit the same.

## TABLE 1: Measurement & Energy/Counter Screens

### TABLE 1.1 System Parameters Screens:

No.	Parameters	On Display			On Modbus			On Mbus		
		3P 4W	3P 3W	1P 2W	3P 4W	3P 3W	1P 2W	3P 4W	3P 3W	1P 2W
1	System Active Power/ Voltage/ Current	✓	✓	✓	✓	✓	✓	✓	✓	✓
2	System Watt-VAr-VA	✓	✓	✓	✓	✓	✓	✓	✓	✓
3	System Power Factor-Frequency	✓	✓	✓	✓	✓	✓	✓	✓	✓
4	System Frequency	✓	✓	✓	✓	✓	✓	✓	✓	✓
5	System %THD Voltage-Current	✓	✓	✓	✓	✓	✓	✓	✓	✓
6	System Max VA-A Demand	✓	✓	✓	✓	✓	✓	✓	✓	✓
7	System Max Import -Export VAr Demand	✓	✓	✓	✓	✓	✓	✓	✓	✓
8	System Max Import Watt Demand	✓	✓	✓	✓	✓	✓	✓	✓	✓
9	System Max Export Watt Demand	✓	✓	✓	✓	✓	✓	✓	✓	✓
10	System VA-A Demand	✓	✓	✓	✓	✓	✓	✓	✓	✓
11	System Import-Export VAr Demand	✓	✓	✓	✓	✓	✓	✓	✓	✓
12	System Import Watt Demand	✓	✓	✓	✓	✓	✓	✓	✓	✓
13	System Export Watt Demand	✓	✓	✓	✓	✓	✓	✓	✓	✓

**NOTE:** The Display screens of TABLE 1.1 can be scrolled through **UP Key**

**TABLE 1.2 Energy Parameters Screens:**

Parameter No.	Parameters	On Display			On Modbus			On Mbus		
		3P 4W	3P 3W	1P 2W	3P 4W	3P 3W	1P 2W	3P 4W	3P 3W	1P 2W
1	System Active Energy Import	✓	✓	✓	✓	✓	✓	✓	✓	✓
2	System Active Energy Export	✓	✓	✓	✓	✓	✓	✓	✓	✓
3	System Reactive Export energy	✓	✓	✓	✓	✓	✓	✓	✓	✓
4	System Reactive Import energy	✓	✓	✓	✓	✓	✓	✓	✓	✓
5	System Apparent energy	✓	✓	✓	✓	✓	✓	✓	✓	✓
6	L1-L2-L3 Active Energy Import	✓	✗	✗	✓	✗	✗	✓	✗	✗
7	L1-L2-L3 Active Energy Export	✓	✗	✗	✓	✗	✗	✓	✗	✗
8	L1-L2-L3 Reactive Export energy	✓	✗	✗	✓	✗	✗	✓	✗	✗
9	L1-L2-L3 Reactive Import energy	✓	✗	✗	✓	✗	✗	✓	✗	✗
10	L1-L2-L3 Apparent energy	✓	✗	✗	✓	✗	✗	✓	✗	✗
11	L1-L2-L3 Total Active Energy	✓	✗	✗	✓	✗	✗	✓	✗	✗
12	L1-L2-L3 Total Reactive Energy	✓	✗	✗	✓	✗	✗	✓	✗	✗
13	System -Total Active Energy	✓	✓	✓	✓	✓	✓	✓	✓	✓
14	System Total Reactive Energy	✓	✓	✓	✓	✓	✓	✓	✓	✓
15	On Hour	✓	✓	✓	✓	✓	✓	✓	✓	✓
16	Run Hour	✓	✓	✓	✓	✓	✓	✓	✓	✓
17	No of Interrupts	✓	✓	✓	✓	✓	✓	✓	✓	✓
18	Tariff 1 Total KWh Energy	✓	✓	✓	✓	✓	✓	✓	✓	✓
19	Tariff 1 Import KWh Energy	✓	✓	✓	✓	✓	✓	✓	✓	✓
20	Tariff 1 Export KWh Energy	✓	✓	✓	✓	✓	✓	✓	✓	✓
21	Tariff 1 Total KVAR Energy	✓	✓	✓	✓	✓	✓	✓	✓	✓
22	Tariff 1 Import KVAR Energy	✓	✓	✓	✓	✓	✓	✓	✓	✓
23	Tariff 1 Export KVAR Energy	✓	✓	✓	✓	✓	✓	✓	✓	✓
24	Tariff 2 Total KWh Energy	✓	✓	✓	✓	✓	✓	✓	✓	✓
25	Tariff 2 Import KWh Energy	✓	✓	✓	✓	✓	✓	✓	✓	✓
26	Tariff 2 Export KWh Energy	✓	✓	✓	✓	✓	✓	✓	✓	✓
27	Tariff 2 Total KVAR Energy	✓	✓	✓	✓	✓	✓	✓	✓	✓
28	Tariff 2 Import KVAR Energy	✓	✓	✓	✓	✓	✓	✓	✓	✓
29	Tariff 2 Export KVAR Energy	✓	✓	✓	✓	✓	✓	✓	✓	✓

**NOTE :** The Display screens of TABLE 1.2 can be scrolled through **E Key**



**TABLE 1.3 Power Parameters Screens:**

Parameter No.	Parameters	On Display			On Modbus			On Mbus		
		3P 4W	3P 3W	1P 2W	3P 4W	3P 3W	1P 2W	3P 4W	3P 3W	1P 2W
1	L1 Watt-VAr-VA	✓	✗	✗	✓	✗	✗	✓	✗	✗
2	L2 Watt-VAr-VA	✓	✗	✗	✓	✗	✗	✓	✗	✗
3	L3 Watt-VAr-VA	✓	✗	✗	✓	✗	✗	✓	✗	✗
4	L1-L2-L3 Power Factor	✓	✗	✗	✓	✗	✗	✓	✗	✗
5	L1-L2-L3 Degree	✓	✗	✗	✓	✗	✗	✓	✗	✗

NOTE: The Display screens of TABLE 1.3 can be scrolled through Down Key.

**TABLE 1.4 Voltage/Current Parameters Screens:**

Parameter No.	Parameters	On Display			On Modbus			On Mbus		
		3P 4W	3P 3W	1P 2W	3P 4W	3P 3W	1P 2W	3P 4W	3P 3W	1P 2W
1	L1-L2-L3 Voltage	✓	✗	✗	✓	✗	✗	✓	✗	✗
2	L12-L23-L31 Voltage	✓	✓	✗	✓	✓	✗	✓	✓	✗
3	L1-L2-L3 Current	✓	✓	✗	✓	✓	✗	✓	✓	✗
4	Neutral Current	✓	✗	✗	✓	✗	✗	✓	✗	✗
5	L1-L2-L3 Voltage %THD	✓	✓	✗	✓	✓	✗	✓	✓	✗
6	L1-L2-L3 Current %THD	✓	✓	✗	✓	✓	✗	✓	✓	✗
7	Current Reversal	✓	✗	✓	✓	✗	✓	✓	✗	✓

NOTE: The Display screens of TABLE 1.4 can be scrolled through V/A Key

## 2.1. Start-up Screens

The meter display a sequence of screens upon every start-up procedure. The first screen is all segment glow screen which ensures that all symbols glow properly. The subsequent screens aids in software identification of the meter as shown below:

sys	BIM	0137	00	0254	J1.1 J1.2
IMP	L1-2	8888	GMKWh		
EXP	PF	8888	DEGNHz		
MAX	L2-3	8888	GMKVarh		
DMD	PF	8888	PF %THD		
MIN	L3-1	8888	GMKVarh		
AVG	PF	8888	MA RPM		
OTF	PF	8888			

All segment glow screen



CRC-1 screen



Software Version screen

## 2.2 Current Reversal Screen

This screen is one of the Voltage / Current Parameter Screens and is useful to indicate if current in any phase is reversed or not. If current in any phase gets reversed, then corresponding phase will be indicated on this screen.

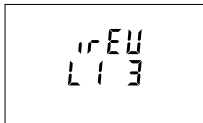

This screen shows that currents in L1 and L3 are reversed.

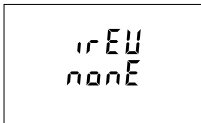

This screen shows that currents in all three phase are correct.

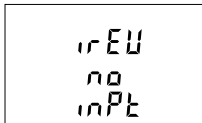

This screen shows that the meter has no current input.

## 2.3 Run Hour

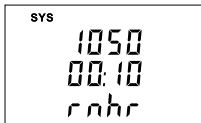

This Screen is one of the Energy Parameter Screens and shows the total no. of hours the load is connected. Even if the Auxiliary supply is interrupted, count of Run hour will be maintained in internal memory & displayed in the format "hours. min".

For example if Displayed count is 105000.10 it indicates 105000 hours & 10 minutes. After 999999.59 run hours display will restart from zero. To reset run hour manually see section Resetting Parameter 3.11.

## 2.4 On Hour



This Screen is one of the Energy Parameter Screens and shows the total no. of hours the Auxiliary Supply is ON. Even if the Auxiliary supply is interrupted count of On hour will be maintained in internal memory & displayed in the format "hours. min".

For example if Displayed count is 105000.10 it indicates 105000 hours and 10 minutes. After 999999.59 On hours display will restart from zero. To reset On hour manually see section Resetting Parameter 3.2.3.1.

## 2.5 Number of Interruption



This Screen is one of the Energy Parameter Screens and displays the total no. of times the Auxillary Supply was Interrupted. Even if the Auxiliary supply is interrupted count will be maintained in internal memory. After 99999 counts, the number of interruptions will restart from zero. To reset No of Interruption manually see section Resetting Parameter 3.11.

**Setup Parameter Screens**

CodE (PassWord)

-  : UP KEY  
 : ENTER KEY  
 : DOWN KEY

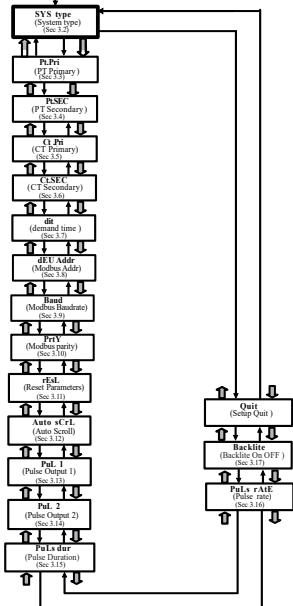

### 3. PROGRAMMING

The following sections comprise step by step procedures for configuring the Energy Meter according to individual user requirements. To access the set-up screens press and hold "▲ UP" and "▼ DOWN" keys simultaneously for 5 seconds. This will take the User into the Password Protection Entry Stage (Section 3.1).

#### 3.1. Password Protection

Password protection can be enabled to prevent unauthorized access to set-up screens, when default password protection is not enabled. Password protection is enabled by selecting a four digit number other than 0000, setting a password of 0000 disables the password protection.

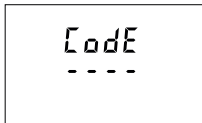

Enter Password, prompt for first digit. Press the "▲" key to scroll the value of the first digit from 0 through to 9, the value rolls back from 9 round to 0, and "▼" key to scroll the value of first the digit from 9 through to 0, the value rolls back from 0 round to 9.

Press the "◀" key to advance to next digit.



In special case where the Password is "0000" pressing the "◀" key when prompted for the first digit advances to the password accepted screen and then pressing the "◀" key again makes the set-up screens accessible to the user.

But instead of pressing the "◀" key, if "▲" or "▼" key is pressed, the user is taken to the "New/change Password" entry stage.

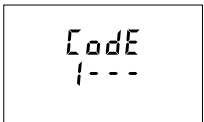

Enter Password, first digit entered, prompt for second digit.

Press the "▲" key to scroll the value of first digit from 0 through to 9, the value rolls back from 9 round to 0 and "▼" key to scroll the value of first digit from 9 through to 0, the value rolls back from 0 round to 9.

Press the "◀" key to advance to next digit.



Code  
13--

Enter Password, second digit entered, prompt for third digit.

Press the "▲" key to scroll the value of first digit from 0 through to 9, the value rolls back from 9 round to 0 and "▼" key to scroll the value of first digit from 9 through to 0, the value rolls back from 0 round to 9.

Press the "←" key to advance to next digit.



Code  
134-

Enter Password, third digit entered, prompt for fourth digit .

Press the "▲" key to scroll the value of first digit from 0 through to 9, the value rolls back from 9 round to 0 and "▼" key to scroll the value of first digit from 9 through to 0, the value rolls back from 0 round to 9.

Press the "←" key to advance to verification of the password.



Code  
1342

Enter Password, fourth digit entered, awaiting verification of the password.

### Password confirmed.



Code  
1342  
done

Pressing "▲" or "▼" key advances to the "New / change Password" entry stage.

Pressing the "←" key advances to the Menu selection (setup menu) screen (see Section 3.2).

### Password Incorrect.

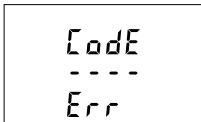

The unit has not accepted the Password entered.

Pressing the "▲" or "▼" key advances to the Enter Password stage.

Pressing the "◀" key exits the Password menu & returns operation to the measurement reading mode.

### New / Change Password



Prompting for first digit.

Press the "▲" and "▼" keys to scroll the value of first digit from 0 through to 9 and from 9 through to 0, respectively with digit roll around feature.

Pressing the "◀" key advances the operation to the next digit and sets the first digit, in this case to "2".



New/ Change Password, first digit entered, prompting for second digit.

Press the "▲" and "▼" keys to scroll the value of second digit from 0 through to 9 and from 9 through to 0, respectively with digit roll around feature.

Pressing the "◀" key advances the operation to the next digit and sets the second digit, in this case to "1".



New/ Change Password, second digit entered, prompting for third digit.

Press the "▲" and "▼" keys to scroll the value of second digit from 0 through to 9 and from 9 through to 0, respectively with digit roll around feature.

Pressing the "◀" key to advance the operation to the next digit and sets the third digit, in this case to "5".



New/ Change Password, third digit entered, prompting for fourth digit .

Press the "▲" and "▼" keys to scroll the value of second digit from 0 through to 9 and from 9 through to 0, respectively with digit roll around feature.

Pressing the "←" key to advance the "New Password Confirmed" and sets the fourth digit, in this case to "3".

### New Password confirmed



Pressing the "▲" or "▼" key returns to the "New/Change Password" stage.

Pressing the "←" key advances to the Setup different Parameters (see Section 3.2).

### 3.2 System Type



This screen is used to set the system type.

Pressing the "←" key to advances to "System Type Edit "Mode".

Pressing "▲" and "▼" Keys scrolls System type value through options available.

Different Valid System types for Meter are as follows

3 Phase 4 wire .

3 Phase 3 Wire.

1 Phase 2 Wire

Pressing "←" Key Accepts "System Type " value.

Pressing "▲" Key advances to Potential Transformer Primary value Screen (See Section 3.3).

**NOTE: Parameter can be set in First 15 Minutes after entering into setup menu and get locked, if still want to change then need to press the reset key, it allows to edit the values for next 15 minutes.**



### 3.3 Potential Transformer Primary Value

The nominal full scale voltage is displayed as the **Line to Line** voltages for all system types. The values displayed represent the voltage in **kilovolts** (note "k" symbol).

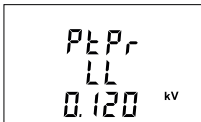

Pressing the "▲" key accepts the present value and advances to the "Potential Transformer Secondary Value" screen (see Section 3.4).

Similarly, pressing the "▼" key accepts the present value and advances to the "System Type" screen. (See Section 3.2)

Pressing the "◀" key advances to the "Potential Transformer Primary Decimal Point Edit" mode.

#### Potential Transformer Primary Digit Edit

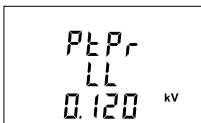

Pressing the "▲" or "▼" key scrolls the value of the most significant digit from 0 through to 9 or 9 through to 0, respectively unless the present displayed Potential Transformer Primary Value together with the Current Transformer Primary Value, previously set, results in a maximum system power of greater than 3750 MVA (1250 MVA per phase) in which case the digit range gets restricted.

Pressing the "◀" key accepts the present value at the cursor position and advances the cursor to the next less significant digit.

The PT Primary value can be set from 100 VL-L to 1200 kVL-L. The value will be forced to previously set VL-L if set less than 100.

**Note:** The flashing digit indicates the cursor position, a steady decimal point is present to identify the scaling of the number until the cursor position coincides with the steady decimal point position. At this stage the digit will flash.

Then the least significant digit has been set, pressing the "◀" key shows "Pls Wait" screen which is followed by the "Potential Transformer Primary Value" screen (see Section 3.3).

**NOTE:** Parameter can be set in First 15 Minutes after entering into setup menu and get locked, if still want to change then need to press the reset key, it allows to edit the values for next 15 minutes.

### 3.4 Potential Transformer Secondary Value

The value must be set to the nominal full scale secondary voltage which will be obtained from the Transformer when the potential transformer (PT) primary is supplied with the voltage defined in 3.3 Potential Transformer Primary voltage. The ratio of full scale primary to full scale secondary is defined as the transformer ratio. The PT Secondary value can be set from 100VL-L to 500 VL-L (according to input voltage range).



Pressing the "▲" key accepts the present value and advances to the "Current Transformer Primary Value" screen (see Section 3.3).

Similarly, pressing the "▼" key accepts the present value and advances to the "Potential Transformer Primary Value" screen (see Section 3.3). Pressing the "◀" key advances to the "Potential Transformer Secondary Digit Edit" mode.

#### Potential Transformer Secondary Digit Edit



Pressing the "▲" or "▼" key scrolls the value of the most significant digit from 0 through 9 or 9 through 0, respectively.

Pressing the "◀" key accepts the present value at the cursor position and advances the cursor to the next less significant digit.

After entering the least significant digit, pressing the "◀" key sets the value and advances to the "Pls Wait" screen followed by the "Potential Transformer Secondary Value" screen (see Section 3.4).

**NOTE : The default value is 400 VLL.**

**NOTE: Parameter can be set in First 15 Minutes after entering into setup menu and get locked, if still want to change then need to press the reset key, it allows to edit the values for next 15 minutes.**

### 3.5 Current Transformer Primary Value

The nominal Full Scale Current that will be displayed as the Line currents. This screen enables the user to display the Line currents inclusive of any transformer ratios, the values displayed represent the Current in Amps.



Pressing the "▲" key accepts the present value and advances to the "Current Transformer Secondary Value" screen (see Section 3.6).

Similarly, pressing the "▼" key accepts the present value and advances to the "Potential Transformer Secondary Value" menu (see Section 3.4).

Pressing the "←" key advances to the "Current Transformer Primary Digit Edit" mode.

#### Current Transformer Primary Digit Edit



Pressing the "▲" or "▼" key scrolls the value of the most significant digit from 0 through 9 or 9 through 0, respectively (with digit roll over feature) unless the present displayed Current Transformer Primary Value together with the Potential Transformer Primary Value results in a maximum system power of greater than 3750 MVA (1250 MVA per phase) in which case the digit range gets restricted, the value will wrap.

**Example:** If primary value of PT is set as 1200 kVL-L (max value) then primary value of Current is restricted to 1804 A.

Pressing the "←" key accepts the present value at the cursor position and advances the cursor to the next less significant digit.

After entering the least significant digit, pressing the "←" key sets the value and advances to the "Pls Wait" screen followed by "Current Transformer Primary Value" screen (see Section 3.2.1.4).

**NOTE:** Default value is set to '5' i.e. 5A.

**NOTE:** Parameter can be set in First 15 Minutes after entering into setup menu and get locked, if still want to change then need to press the reset key, it allows to edit the values for next 15 minutes.

### 3.6 Current Transformer Secondary Value (Only applicable for NMID32 Model)

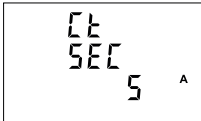

This screen is used to set the secondary value for Current Transformer. Secondary value "5" for **5A** or "1" for **1A** can be selected.

Pressing the "▲" key accepts the present value and advances to the "Demand Integration time" Screen (see Section 3.7).

Similarly, pressing the "▼" key accepts the present value and advances to the "Current Transformer Primary Value" screen (see Section 3.5).

Pressing the "←" key advances to the "CT Secondary Value Edit" mode and keys "▲" and "▼" scroll the value through the options available.

Pressing the "←" key sets the option selected and advances to "Pls Wait" screen followed by "Current Transformer Secondary Value" screen (see Section 3.6).

**NOTE :** CT Secondary has fixed value for RJ12 Model (refer technical specifications) and hence this setting screen is not available for the RJ12 Model..

### Current Transformer Secondary Digit Edit



Pressing the "▲" or "▼" key scrolls the value of the most significant digit from 0 through 9 or 9 through 0, respectively.

Pressing the "←" key accepts the present value at the cursor position and advances the cursor to the next less significant digit.

After entering the least significant digit, pressing the "←" key sets the value and advances to the "Pls Wait" screen followed by the "Current Transformer Secondary Value" screen (see Section 3.6).

**NOTE :** The default value is 5 A.

**NOTE:** Parameter can be set in First 15 Minutes after entering into setup menu and get locked, if still want to change then need to press the reset key, it allows to edit the values for next 15 minutes.

### 3.7 Demand Integration Time

This screen is used to set the period over which current and power readings are to be integrated. The Unit of displayed value is **minutes**.

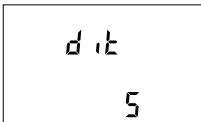

Pressing the "←" key enables editing and pressing keys "▲" and "▼" allows scrolling to select desired value. The user can select value upto 60 min.

Once the desired value is selected, pressing "←" key confirms the selection and advances to "Pls Wait" screen followed by "Demand Integration Time" screen (see Section 3.7).

Pressing the "▲" key advances to "Address Setting" screen (see Section 3.8) and pressing the "▼" key advances to "Current Transformer Secondary Value Screen (see Section 3.6).

### 3.8 Address Setting



This screen allows the user to set RS 485 address for the meter.

The allowable range of addresses for MODBUS is 1 to 247 and for MBUS the range is 1 to 250.

Press "▲" key to advance to "Baud Rate" screen (see Section 3.9) or press the "▼" key to advance to the "Demand Integration Time" screen (see Section 3.7)



Press "←" to enter into edit mode, prompt for first digit.

Press the "▲" and "▼" keys to scroll the value of the first digit. Press the "←" key to advance to next digit.

Similarly, enter second and third digits of address. After entering third digit, pressing "←" key confirms the selection and shows "Address Setting" screen (see Section 3.8).

**NOTE : The default setting is '1'.**

### 3.9 Baud Rate



This screen allows the user to set Baud Rate. The values displayed on screen are in kbaud.

Pressing "▲" key accepts the present value and advance to the "Parity Selection" screen (see Section 3.10) and pressing the "▼" key accepts the present value and advance to the "Address Setting" screen (see Section 3.8).

Pressing the "←" key advances to the "Baud Rate Edit" mode and "▲" & "▼" keys scrolls the value through **4.8, 9.6, 19.2, 38.4 and 57.6** kbaud for ModBus and **0.3, 0.6, 1.2, 2.4, 4.8 and 9.6** kbaud for MBUS.

Pressing the "←" key sets the value and shows the "Baud Rate" screen (see Section 3.9).

**NOTE: Default value is set as '9.6' for MODBUS.**

**NOTE: Default value is set as '2.4' for MBUS.**

### 3.10 Parity

This screen allows the user to set Parity & number of stop bits of RS 485 / MBUS port.

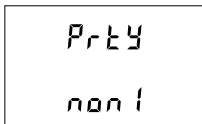

Pressing "▲" key accepts the present value and advances to "Resetting Parameters" screen (see section 3.11). Similarly, pressing "▼" key accepts the present value and advances to "Baud Rate" screen (see section 3.9).

Pressing the "←" key advances to the "Parity & Stop bit Edit" mode & keys "▲" and "▼" scrolls the value through:

**nonE1** : no parity with one stop bit      **nonE2** : no parity with two stop bit  
**EvEn** : even parity with one stop bit      **odd** : odd parity with one stop bit

Pressing "←" key sets the value and advances to "Parity Selection" screen (see Section 3.10).

**NOTE 1: For MODBUS the default value is set as 'nonE1'.**

**NOTE 2: For MBUS the value is always 'EvEn1' and cannot be changed.**

### 3.11 Resetting Parameter

This screen allows the users to reset Partial Energy, Demand.

#### Reset Parameters



This screen allows user to reset the resettable parameters.

Pressing "▲" key accepts the present status and advance to the "Auto scroll" screen (see Section 3.12). Similarly, pressing "▼" key accepts the present status and advances to the "Parity" screen (see Section 3.10).

#### Edit mode



Pressing "▲" & "▼" keys scroll through the parameters given below:

**ALL:** reset all Resettable parameters.

**dmd :** reset all Demand parameters.

**P-En:** reset all Partial energies.

**HiGh:** reset Maximum values of Voltage & Current.

**LoW:** reset all Minimum values of Voltage & Current

**Hour:** reset Run hour & On hour.

**intr:** reset No. of auxillary supply interruption count.

Pressing "◀" key selects the status displayed and advances to "Auto Scrolling" screen (see Section 3.12).

**NOTE: (1) Default value is set to 'NONE'.**

### 3.12 Auto Scrolling



This screen allows user to enable auto screen scrolling.

Pressing "▲" key accepts the present status and advance to the "Pulse Output 1" screen (see Section 3.13). Similarly, pressing "▼" key accepts the present status and advances to the "Resetting Parameters" screen (see Section 3.11).

Pressing the "◀" key allows editing and keys "▲" and "▼" allows the user to select either 'Yes' to enable autoscroll and 'No' to disable auto-scroll.

### 3.13 Pulse Output 1

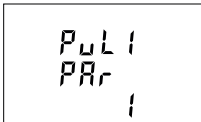

This screen is used to set the pulse output 1 parameter.

Pressing "▲" key advances to "Pulse Output 2" screen (see Section 3.14) whereas pressing "▼" key advances to "Auto Scrolling Screen". (See Section 3.12)

Pressing "←" key advances to Pulse Output 1 Edit Mode Screen. and "▲" and "▼" scrolls the value through

"0": "System Active Import"      "1": "System Active Export"  
"2": "System Reactive Import"    "3": "System Reactive Export"  
"24": "Total System Active Energy"  
"25": "Total System Reactive Energy".

Pressing "←" accepts the Present value of Pulse Output 1 and "▲" key

### 3.14 Pulse Output 2

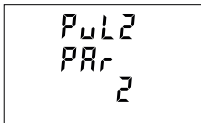

This screen is used to set the pulse output 2 parameter.

Pressing "▲" key advances to "Pulse Duration" screen (see Section 3.15) whereas pressing "▼" key advances to "Pulse Output 1". (See Section 3.13)

Pressing "←" key advances to Pulse Output 2 Edit Mode Screen and "▲" and "▼" scrolls the value through

"0": "System Active Import"      "1": "System Active Export"  
"2": "System Reactive Import"    "3": "System Reactive Export"  
"24": "Total System Active Energy"  
"25": "Total System Reactive Energy".

Pressing "←" accepts the Present value of Pulse Output 1 and "▲" key advances to "Pulse Duration" Screen(See Section 3.15).

### 3.15 Pulse Duration



This screen allows the user to set Digital Output pulse duration time in milliseconds.

Pressing "▲" key accepts the present value and advance to "Pulse Rate" screen ( see section 3.16). Similarly, pressing "▼" key accepts the present value and advance to "Pulse Output 2" screen ( see section 3.14).

Pressing the "←" key advances to "Pulse Duration Edit" mode and "▲" and "▼" keys scroll the value through **60, 100 and 200** ms.

Pressing the "←" key selects the value and advances to "Pulse Duration" menu (see Section 3.15).

**NOTE: Default value is set to '100' ms.**



### 3.16 Pulse Rate



PULSE  
RATE  
1

Pressing "▲" key accepts the present selection and takes to the "Backlit" Screen (See section 3.17) and pressing "▼" key accepts the present selection and takes to the "Pulse Duration" screen (see Section 3.15).

Pressing the "←" key takes the user into edit mode.

In Edit Mode, pressing "▲" and "▼" keys allows the user to scroll between 1,10,100,1000 and pressing "←" key confirms the selection.

Setting the value to 1 means 1 pulse per 1kWh/kVArh.

Setting the value to 10 means 1 pulse per 10kWh/kVArh.

Setting the value to 100 means 1 pulse per 100kWh/kVArh.

Setting the value to 1000 means 1 pulse per 1000kWh/kVArh.

#### \*The Pulse rate is auto set or restricted

If CT\*PT is less than or equal to 3333.33 then the settable values are 1,10,100,1000.

If CT\*PT is less than or equal to 33333.33 then the settable values are 10,100,1000.

If CT\*PT is less than or equal to 333333.33 then the settable values are 100,1000.

If CT\*PT is greater than 333333.33 then value will auto set to 1000.

#### \*NOTE:

- 1)  $CT*PT = 3 \times CT(\text{Primary}) \times PT(\text{Primary})$  L-N for 3 Phase 4 Wire
- 2)  $CT*PT = \text{Root}3 \times CT(\text{Primary}) \times PT(\text{Primary})$  L-L for 3 Phase 3 Wire
- 3)  $CT*PT = CT(\text{Primary}) \times PT(\text{Primary})$  L-N for 1 Phase 2 Wire

### 3.17 Backlit



backlit  
5

This screen allows the user to switch the backlit on or config the off-delay time.

Pressing the "▲" and "▼" keys advances to "Quit Setup" (see Section 3.18) and "Pulse Rate" menu (see Section 3.16), respectively.

Pressing the "←" key takes the user into edit mode.

## Backlit Edit Mode

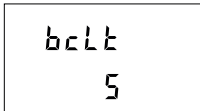

In Edit Mode, pressing "▲" and "▼" keys allows the user to scroll between 5, 10, 30, 60, 120 and pressing "←" key confirms the selection.

Pressing "←" key again advances to editing mode whereas pressing "▲" or "▼" keys advances to Changes the values of off-time delay of Backlit.

## 3.18 Setup Quit

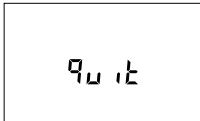

This screen allows the user to exit the setup menu.

Pressing the "▲" key advances to the System Type Selection (see Section 3.2.) screen and pressing the "▼" key advances to the Backlit (see Section 3.2.17) menu.

Pressing "←" key quits from the Setup menu and advance to measurement screen at which the setup screen was accessed.

## 4. Digital Output:

The Meter is provided with S0 as pulse output

### 4.1 Pulse Output:

Pulse Output is the opto-coupler based S0 which can be used to drive an external mechanical counter for energy measurement. The Pulse Output can be configured to the parameters maintained in TABLE 2.1 through setup parameter screen:

### TABLE 2: Pulse Output Tables

TABLE 2.1: Parameters for Pulse Output

Parameter Number	Parameter	3P4W	3P 3W	1P 2W
0	Sys Active Import	✓	✓	✓
1	Sys Active Export	✓	✓	✓
2	Sys Reactive Import	✓	✓	✓
3	Sys Reactive Export	✓	✓	✓
24	Total Sys Active Energy	✓	✓	✓
25	Total Sys Reactive Energy	✓	✓	✓

## 5. Phasor Diagram:

**Quadrant 1:**  $0^\circ$  to  $90^\circ$

**Quadrant 3:**  $180^\circ$  to  $270^\circ$

**Quadrant 2:**  $90^\circ$  to  $180^\circ$

**Quadrant 4:**  $270^\circ$  to  $360^\circ$

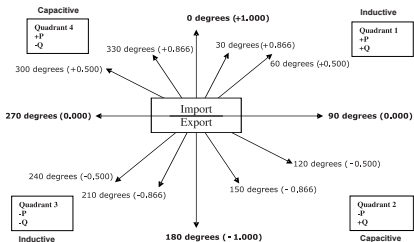

Connections	Quadrant	Sign of Active Power ( P )	Sign of Reactive Power ( Q )	Sign of Power Factor ( PF )	Inductive / Capacitive
Import	1	+ P	+ Q	+	L
Import	4	+ P	- Q	+	C
Export	2	- P	+ Q	-	C
Export	3	- P	- Q	-	L

Inductive means Current lags Voltage

Capacitive means Current leads Voltage

When the Meter displays Active power (P) with "+" (positive sign), the connection is "**Import**".

When the Meter displays Active power (P) with "-" (negative sign), the connection is "**Export**".

## 6. Installation

The Instrument should be mounted in a reasonably stable ambient temperature and where the operating temperature is within the range defined by the technical specification. Vibration should be kept to a minimum and the product should not be mounted where it will be subjected to excessive direct sunlight.

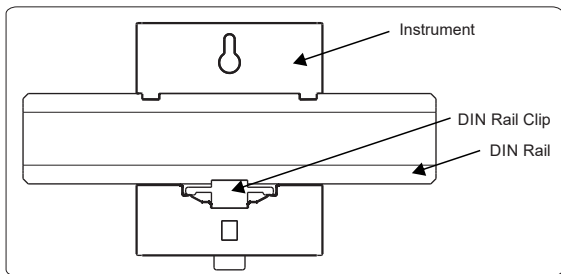

### Caution

1. In the interest of safety and functionality this product must be installed by a qualified engineer, abiding by any local regulations.
2. Voltages dangerous to human life are present at some of the terminal connections of this unit. Ensure that all supplies are deenergised before attempting any connection or disconnection.
3. These products do not have internal fuses therefore external fuses must be used to ensure safety under fault conditions.
4. The installer is responsible for selecting appropriate supply side protection overcurrent device so, it is must to ensure that the maximum current rating and characteristics of that device.

### Warning

1. Qualified personnel familiar with applicable codes and regulations must perform the installation.
2. Utilize insulated tools for device installation.
3. Install a fuse, thermal cut-off, or single-pole circuit breaker on the supply line, not on the neutral line.

## 6.1 EMC Installation Requirements

This product has been designed to meet the certification of the EU directives when installed to a good code of practice for EMC in industrial environments, e.g.

1. Screened output and low signal input leads or have provision for fitting RF suppression components, such as ferrite absorbers, line filters etc., in the event that RF fields cause problems.

**Note :** It is good practice to install sensitive electronic instruments that are performing critical functions, in EMC enclosures that protect against electrical interference which could cause a disturbance in function.

2. Avoid routing leads alongside cables and products that are, or could be, a source of interference.

3. To protect the product against permanent damage, surge transients must be limited to 2kV pk. It is good EMC practice to suppress differential surges to 2kV at the source. The unit has been designed to automatically recover in the event of a high level of transients. In extreme circumstances it may be necessary to temporarily disconnect the auxiliary supply for a period of greater than 5 seconds to restore correct operation. The Current inputs of these products are designed for connection in to systems via Current Transformers only, where one side is grounded.

4. ESD precautions must be taken at all times when handling this product.

## 6.2 Case Dimensions

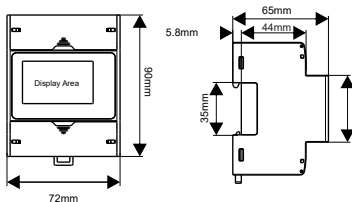

For NMID32 models

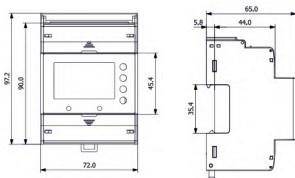



For NMID31 models

## 6.3 Wiring

Input connections are made directly to screw-type terminals with indirect wire pressure. Numbering is clearly marked at the connector location. Choice of cable should meet local regulations. Terminal for both Current and Voltage inputs will accept upto  $4\text{mm}^2$  (12AWG) solid or  $2.5\text{mm}^2$  stranded cable.

**Note :** It is recommended to use **wire with** insulated pin type lug for **connection with meter.**

**Wire:** It is suggested to use wire with a temperature rating of at least 83 Deg. C

	ISO 7000-0434B(2004-01)	CAUTION
	ISO 7000-1641	Operating Instructions

### For CT Connected Meters:

Connections	Cable Size (mm <sup>2</sup> )	Torque (Nm)
<b>L, N, I-in, I-out</b>	1 - 2.5 mm <sup>2</sup> use pin type insulated lugs	0.4 Nm
<b>B, A, G / M+,M-,SO1+, SO1-, SO2+, SO2-, TARIFF INPUTS.</b>	1 - 2.5 mm <sup>2</sup> Standard with insulated pin types lugs.	0.4 Nm

### For RJ-12 CT Meters:

Connections	Cable Size (mm <sup>2</sup> )	Torque (Nm)
<b>L,N</b>	1 - 2.5 mm <sup>2</sup> use pin type insulated lugs	0.4 Nm
<b>B, A, G / M+,M-,SO1+, SO1-, SO2+, SO2-, TARIFF INPUTS.</b>	1 - 2.5 mm <sup>2</sup> Standard with insulated pin types lugs.	0.4 Nm

## 6.4 Auxiliary Supply

Meter should ideally be powered from a dedicated supply, however powered from the signal source, provided the source remains within it may be the limits of the Chosen auxiliary voltage range.

## 6.5 Fusing

It is recommended that all voltage lines are fitted with 1 Amp HRC fuses or circuit breaker to disconnecting the device.

Specification : Disconnecting device used must be relevant requirements of IEC-60974-1 & IEC-60947-3

For Aux: At most 1.5 times of applied power supply

For measuring input : At most 1.5 times of measuring input.

( Switching time of the device should be < 0.1 sec for Aux & I/P both )

## 6.6 Earth/Ground Connections

For safety reasons, CT secondary connections should be grounded in accordance with local regulations.

**\*Note : Refer this Manual wherever the CAUTION symbol is marked.**

## 6.7 Sealing

As per the MID standard It is mandatory to seal the meter after complete connections of the meter to avoid tampering.

In the Packing box, 2 utility seal for NMID32 & 3 utility seal for NMID31 are provided.

Follow the below procedure for sealing the meter:

- 1) After all the connections close the upper terminal cover as shown in below figure.
- 2) In order to lock the terminal cover, press at the two edge of the terminal cover.
- 3) Now, insert the seal cord through the terminal sealing hole of housing & terminal cover.
- 4) Then insert the cord into the security seal hole and rotate the seal cap 2 to 3 times to lock the cord.
- 5) After sealing the meter brake the seal cap.
- 6) Repeat these steps for the lower terminal cover.
- 7) If the meter is NMID31 another sealing required for RJ12 Connector cover.
- 8) After inserting / connection of the RJ12 CT connector into the meter, push the transparent RJ12 Connector cover cap toward down as shown in below figure.
- 9) Now, insert the seal cord through both side of the housing hole & transparent RJ12 Connector cover cap.
- 10) Then insert the cord into the security seal hole and rotate the seal cap 2 to 3 times to lock the cord.
- 11) After sealing the meter brake the seal cap.

- 7) If the meter is NMID31 another sealing required for RJ12 Connector cover.
- 8) After inserting / connection of the RJ12 CT connector into the meter, push the transparent RJ12 Connector cover cap toward down as shown in below figure.
- 9) Now, insert the seal cord through both side of the housing hole & transparent RJ12 Connector cover cap.
- 10) Then insert the cord into the security seal hole and rotate the seal cap 2 to 3 times to lock the cord.
- 11) After sealing the meter brake the seal cap.



## 7. Errors and Dignostics

The instruments continuously monitors for various kinds of errors and warning conditions. The errors if any are found are immediately displayed on screen, since the errors are categorized as conditions which hampers the normal operation of instruments thus they need to be immediately replaced. The corresponding error register are also mapped on Modbus Registers for remote monitoring of instrument health.



Error : CRC mismatch in the calibration coefficient

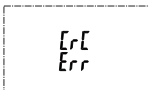

Error : CRC Error



Error : EEPROM Full notification



Error : EEPROM CRC error or Corruption

The error status is also available on the Modbus:

Bit 0	Cal CRC Error
Bit 1	CRC Err
Bit 2	EEPROM Full
Bit 3	EEPROM CRC error or Corruption

## 8. Connection Diagrams



2,5,8	:L1,L2,L3
11	:Neutral
1 & 3	:L1 Current In & L1 Current Out
4 & 6	:L2 Current In & L2 Current Out
7 & 9	:L3 Current In & L3 Current Out
13 & 14	:Aux Terminal
35,36 & 38,39	:Pulse Output Terminal
20,21	:Tariff input Terminal
28,29,30	:RS485 Terminal 28:A+,29:B-,30:G (in Modbus Model)
	:Mbus Terminal 28:M+,30:M- (in Mbus Model)

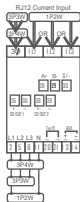

2,5,8	:L1,L2,L3
11	:Neutral
13 & 14	:Aux Terminal
35,36 & 38,39	:Pulse Output Terminal
20,21	:Tariff input Terminal
28,29,30	:RS485 Terminal 28:A+,29:B-,30:G (in Modbus Model)
	:Mbus Terminal 28:M+,30:M- (in Mbus Model)

## 8.2 Connection Diagrams for RJ12 Model

Top View

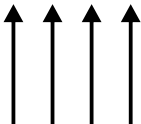
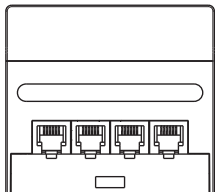

1 Ø	1 Ø	1 Ø	3 Ø
CT	CT	CT	CT
Ph3	Ph2	Ph1	

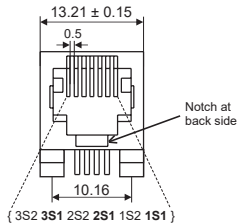

Meter Side RJ 12 Connection

## 9. Instrument Installation

### 9.1 Installation with DIN Rail

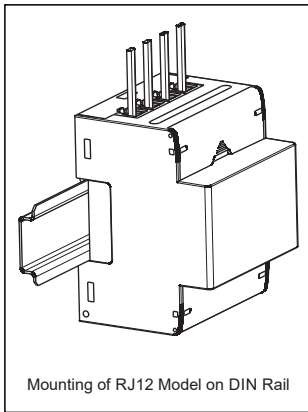
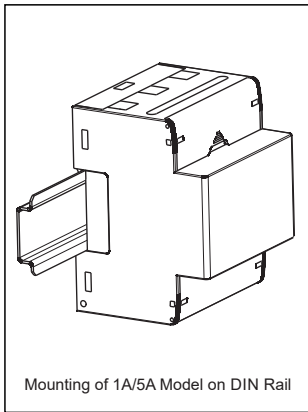

## 9.2 RJ12 Current Transformers



3 Phase RJ12 CT



3 Phase Nano CT with RJ12



Single Phase RJ12 CT

## 10. Connection for Optional Pulse Output / Tariff Input / RS-485

### Location of Modbus, 2 Pulse Outputs, 1 Tariff Input & Reset Key

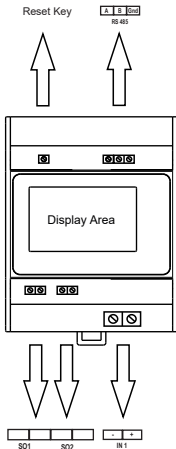

## 11. Safety Instructions:

### Warning:



This indicates potential danger that can lead to death, serious injury, or significant material damage if not followed. Ignoring these instructions can cause death, serious injury, or major material damage.

### Caution:



This indicates electric shock risk, which can also result in death, serious injury, or significant material damage. Risk of electric shock. Not taking precautions can result in death, serious injury, or major material damage.

### Qualified Personnel:

- Only qualified individuals should install and operate this device.
- Qualified personnel are those with authorization and knowledge of labeling and grounding electrical equipment according to local safety regulations.

### Intended Use:

- Use the device only as specified in the catalog and user manual.
- Use only with devices and components.

### Proper Handling:

- Ensure proper transport, storage, installation, connection, operation, and maintenance for reliable operation.
- Be aware that parts of the meter may carry dangerous voltages during use.

### Safety Precautions:

1. Use insulated tools suitable for the meter's voltages.
2. Do not connect the meter while the circuit is powered.
3. Install the meter in a dry environment within a suitable IP-rated enclosure.
4. Follow local installation codes and regulations.
5. Avoid installing in explosive areas or places with dust, mildew, or insects.
6. Use wires suitable for the meter's maximum current and ensure correct AC wire connections before powering the meter.
7. Do not touch the meter's connection clamps with bare hands or conductive materials to avoid electric shock.
8. Replace protection covers after installation.
9. Maintenance and repairs should only be performed by qualified personnel.
10. Do not break any seals on the meter as it may affect functionality, accuracy, and void the warranty.
11. Handle the meter carefully to avoid damaging internal components.
12. Ensure all clamps are properly tightened and wires fit securely to avoid bad contact and potential sparks.
13. If required clean the device with a microfiber cloth, keeping liquids away from all components.

## 12. Specification

### System Types

3 Phase 3 Wire / 4 Wire or Single Phase programmable on site

### Voltage Inputs

Nominal Input Voltage Vn (AC RMS)	230VLN(400VLL)
System PT Primary Values	100VLL to 1200 kVLL, programmable on site
System Secondary Values	100VLL to 500VLL programmable on site
Measuring Range	57.5VLN to 289 VLN
Max Continuous Voltage	120% of Nominal Value
Nominal Input Voltage Burden	<0.3 VA approx. per Phase (at nominal 240V)
Nominal Frequency	50 Hz
Operating frequency Range	49 Hz To 51Hz

### Current Input in-built CT Model

Current Measurements Parameter	1A	5A
Starting Current (Ist =0.04*Itr)	2mA	10mA
Minimum Current (Imin =0.2*Itr)	10mA	50mA
Transitional Current (Itr)	50mA	250 mA
Nominal Current (In =20*Itr)	1A	5A
Maximum Current	(Imax=120*Itr) 6 A	(Imax=24*Itr) 6A
Operating Current Range	10mA -1A(6 A)	50mA-5A(6A)
Short Circuit Over Current	20*Imax for 0.5 seconds	
Power Consumption in Current Circuit	<1VA per Phase	

### Current Input in RJ12 Model

Current Measurements Parameter	RJ 12 Model
Starting Current (Ist =0.04*Itr)	0.2mA
Minimum Current (Imin =0.2*Itr)	1mA
Transitional Current (Itr)	5mA
Nominal Current (In =20*Itr)	100mA
Maximum Current (Imax=24*Itr)	120mA
Operating Current Range	1mA -100mA(120mA)
Short Circuit Over Current	20*Imax for 0.5 seconds
Power Consumption in Current Circuit	<0.05VA per Phase



**Auxiliary supply:**

Voltage	100-550V AC/DC (230V AC/DC nominal)
Frequency	50 Hz
Burden	< 6VA approx. (at nominal value)

**Reference Conditions for Accuracy:**

Reference Temperature	23°C +/- 2°C
Influence of Temperature	0.01% / °C for Voltage, 0.025% / °C for Current
Input Waveform	Sinusoidal (Distortion factor 0.005)
Input Frequency	50 Hz ± 2%
Auxiliary Supply Frequency	50 Hz ± 1%
Total Harmonic Distortion	THDv <= 50% upto 31st at Vn THDi <= 60% upto 31st at In

**Accuracy:**

Active Energy	Class B as per EN 50470 - 3 Class 1 as per IEC 62053 - 21
Reactive Energy	±2%
Apparent Energy	±1%
Active Power	±0.2% of nominal value
Reactive Power	±1.0% of nominal value
Apparent Power	±0.2% of nominal value
Power Factor	±1%
Voltage	±0.2% of nominal value
Current	±0.2% of nominal value
Frequency	±0.1% of nominal value
THD (V/ I) w.r.t fundamental	±5% (upto 31st Harmonics)

**Pulse Outputs:**

SO1 and SO2	Passive Opto-isolated
Contact Ranges	5-27V DC, 27 mA DC (max)
Pulse Duration	60, 100 and 200 millisecond
Pulse Rate	1 pulse per kWh/kVARh

**Impulse LED:**

Impulse Rate 6400 pulse per kWh

**Communication Interface:****MODBUS**

Protocol RS485 MODBUS  
Baudrate 4.8 / 9.6 / 19.2 / 38.4 / 57.6 kbps  
Data Width 8  
Parity- Stop Bits None -1 / None -2 / Even -1 / Odd -1  
Response Time 200 millisecond at 9.6 kbps Baudrate

**MBUS**

Protocol EN13757-3 MBUS  
Baudrate 0.3 / 0.6 / 1.2 / 2.4 / 4.8 / 9.6 kbps  
Data Width 8  
Parity- Stop Bits Even -1

**Display Ranges:**

Active Energy 0.001-99999999 kWh  
Reactive Energy 0.001-99999999 kVARh  
Apparent Energy 0.001-99999999 kVAh

**Tariff Input:**

0 V Low  
230 V High

**Installation:**

Installation Indoor  
Enclosure IP51(Front side) and IP 20 (Terminal side)  
(IEC 60529 : 2001)  
The device should only be mounted within an external enclosure, such as a meter or switch cabinet. This enclosure must offer a minimum of IP 51 protection and should be situated indoors. Only under these conditions protection against dust and water penetration assured in compliance with the IEC 62052-11)

Housing	(4 Module DIN 43880)
Dimensions	72 mm X 90 mm X 65 mm (for NMID32 models) 72 mm X 97.2 mm X 65 mm (for NMID31 models)
Weight	300 gm
Mounting	35 mm DIN Rail
<b>Safety:</b>	
Safety Standard	According to 62052-31:2015
Installation Category	III
Protective Class	II
AC Voltage Test	4kV 50Hz for 1 Minute between all electrical circuits
Impulse Voltage Withstand	6 kV (1.2 microsecond waveform)
Housing flame Resistance	Flammability Class V-0 acc to UL-94, Self Extinguishing, Non-Dripping, Free of Halogen
<b>Environmental Conditions:</b>	
Mechanical Environment	M1
Electromagnetic Environment	E2
Operating Temperature	-25°C to +55°C
Storage/Transport Temperature	-40°C to +70°C
Relative Humidity	0... 95% (Non Condensing)
Shock	Half sine wave, peak acceleration 30gn, (300 m/s ), pulse duration 18msec
Vibration	10...150Hz, f<60 Hz 0.075mm constant amplitude, f>60Hz 1g constant acceleration, 10 sweep cycles per axis
Altitude	< 2000 m

## LUMEL S.A.

ul. Słubicka 4, 65-127 Zielona Góra, Poland  
tel.: +48 68 45 75 100  
[www.lumel.com.pl](http://www.lumel.com.pl)

---



### **Technical Support & Export Department:**

tel.: +48 68 45 75 146, (WhatsApp) +48 536 550 007  
+48 68 45 75 130, (WhatsApp) +48 733 393 603  
e-mail: [export@lumel.com.pl](mailto:export@lumel.com.pl)

### **Calibration & Attestation:**

e-mail: [laboratorium@lumel.com.pl](mailto:laboratorium@lumel.com.pl)